

# TABLE OF CONTENTS

<i>Project Tender (If applicable).</i>	<i>1</i>
<i>Services Provided by N.E.D.F.</i>	<i>2</i>
<i>Standard Steel Door Frames – Data Sheet.</i>	<i>3</i>
<i>Standard Steel Door Frames – Profiles.</i>	<i>4 – 5</i>
<i>Fire Rated Steel Door Frames – Data Sheet.</i>	<i>6</i>
<i>Fire Rated Steel Door Frames – Profiles.</i>	<i>7 – 9</i>
<i>Steel Door Frames – Fixing Methods.</i>	<i>10</i>
<i>Steel Door Frames – Frame Details.</i>	<i>11</i>
<i>Special Steel Door Frames – Profiles.</i>	<i>12</i>
<i>Special Steel Door Frames.</i>	<i>13</i>
<i>Steel Cavity Slider Units – Data Sheet.</i>	<i>14</i>
<i>Steel Cavity Slider Units – (Fully Assembled Model) – Schematic.</i>	<i>15</i>
<i>Steel Sheeted Door Panels – Data Sheet.</i>	<i>16</i>
<i>Steel Sheeted Door Panels – Schematic.</i>	<i>17</i>
<i>Steel Door Panels – Data Sheet.</i>	<i>18</i>
<i>Steel Door Panels – Schematic.</i>	<i>19</i>
<i>Steel Louvre Door Panels / Fixed Louvres – Data Sheet.</i>	<i>20</i>
<i>Steel Louvre Door Panels – Schematic.</i>	<i>21– 24</i>
<i>Chevron Louvre – Schematic.</i>	<i>25</i>

# SERVICES PROVIDED

NEDF is the manufacturer and supplier of:

- ◆ Standard & Fire Rated Steel Door Frames
- ◆ Special Steel Door Frames (Made to measure)
- ◆ Lead Lined Steel Door Frames
- ◆ Stainless Steel Door Frames
- ◆ Cavity Slider Door Frames
- ◆ Steel Louvre Doors & Fixed Panels
- ◆ Steel Doors
- ◆ Steel Security Doors
- ◆ Steel Sheeted Timber Doors

We are also the supplier of:

- ◆ Fire Rated & Smoke Doors
- ◆ Solid Core Timber Doors
- ◆ Hollow Core Timber Doors

NEDF is qualified for the "Certification" of Fire Rated Door sets.

NEDF also carries out general Sheet Metal Work in Zinc, Galvanised, Colourbond or Stainless Steel. This includes Light Industrial Fabrication on Gates, Rails, Grilles etc..

N.E.D.F. is proudly Australian owned and uses only "Australian" Steel for all products manufactured.

# STANDARD STEEL DOOR FRAMES

## PRODUCT DATA SHEET

*Standard Steel Door Frames* are manufactured from either 1.1mm or 1.5mm Zincanneal, Galvanised or Grade 304 "Brushed" Stainless Steel sheet conforming to AS1397.

Frames incorporate either a double or single rebate as may be required or as a Plain Frame for Double Acting or Sliding doors. Standard Steel Door Frames are supplied either unassembled or welded, smoothed and shop primed with a rust inhibitive, phosphate based primer.

Stand Frames are manufactured and supplied with:

- ◆ Three Hinge plates (drilled & tapped) per hinge stile
- ◆ Provision for Universal Lock Strike – 1030mm from floor
- ◆ Removable Spreader Bars
- ◆ Mortar Boxes for Masonry applications
- ◆ Base Fixing Plates
- ◆ Slot & Lug assembly for "Un-Assembled" Frames
- ◆ Two Resilient Rubber Buffers per Lock Stile

Standard Steel Door Frames incorporate a 15mm Stop and a rebate to accommodate a 35mm, 40mm or 45mm door panel. For Solid Core Doors, a third hinge is fitted.

Generally frames are supplied with galvanised wire fixing ties for new masonry walls. They may be fitted with Countersunk Fixing Holes & Tube Spacers for existing walls. Stud Clips or Fixing Straps are used for Stud Walls.

All Frames are warranted as per N.E.D.F. **"Terms & Conditions of Sale"**

# STANDARD STEEL DOOR FRAME PROFILES

**TYPE S1**

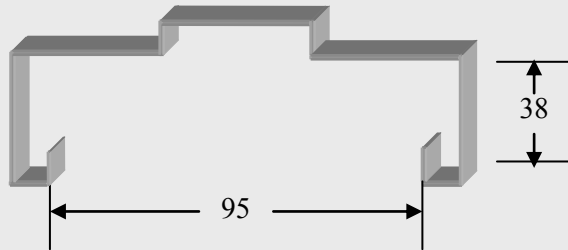

**Suitable for:**

**90mm Block work  
64mm Stud + 13mm Lining Each Side**

**TYPE S2**

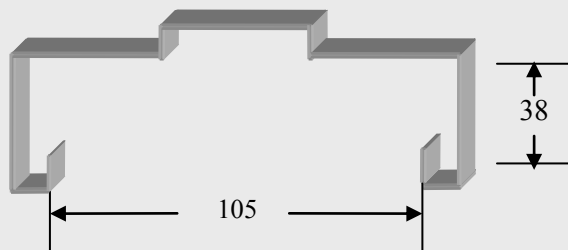

**Suitable for:**

**100mm Block work  
76mm Stud + 13mm Lining Each Side**

**TYPE S3**

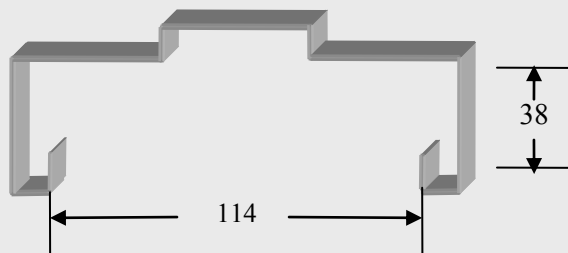

**Suitable for:**

**114mm Brickwork  
90mm Stud + 10mm Lining Each Side**

**TYPE S4**

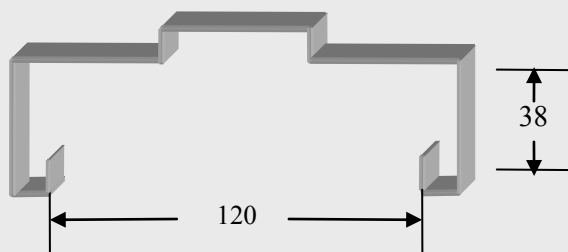

**Suitable for:**

**90mm Stud + 13mm Lining Each Side**

**Manufacturing Tolerances +/- 2mm**

# STANDARD STEEL DOOR FRAME PROFILES

**TYPE S5**

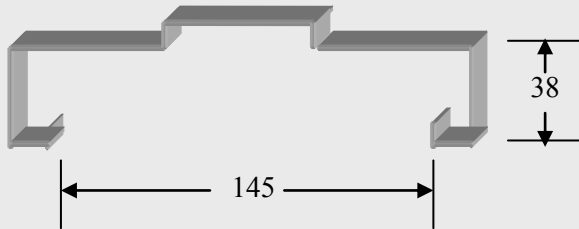

Suitable for:

140mm Blockwork

Cavity Wall

**TYPE S6**

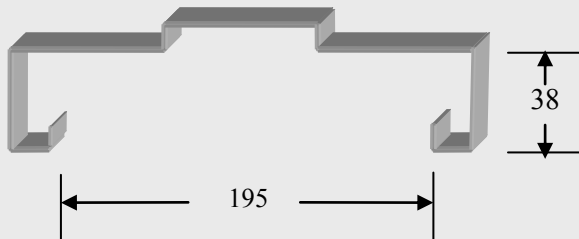

Suitable for:

190mm Blockwork

**TYPE S7**

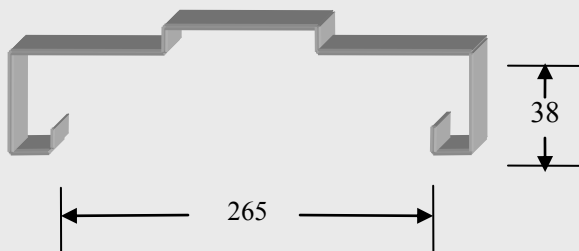

Suitable for:

Cavity Brick Wall

**TYPE S8**

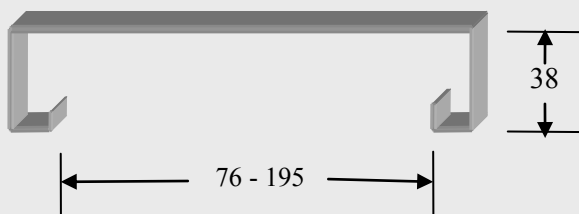

Suitable for:

Surface Mounted Sliding Doors &  
Double Acting Doors

Manufacturing Tolerances +/- 2mm

# FIRE RATED STEELDOOR FRAMES

## PRODUCT DATA SHEET

*Fire Rated Steel Door Frames* are manufactured to the requirements of AS/NZ1905.1 from either 1.1mm, 1.5mm or 2.5mm Zincanneal or Galvanised Steel conforming to AS1397.

Frames incorporate either a double or single rebate as may be required. Fire Rated Steel Door Frames are supplied welded, smoothed and shop primed with a rust inhibitive, phosphate based metal primer.

Frames are manufactured and supplied with:

- ◆ Three Hinge plates (drilled & tapped) per hinge stile
- ◆ Provision for Universal Lock Strike per lock stile – 1030mm from floor.
- ◆ Removable Spreader Bars
- ◆ Mortar Boxes for Masonary Wall applications
- ◆ Base Fixing Plates
- ◆ Two Resiliant Rubber Buffers per Lock stile
- ◆ Re-enforcing for a Surface Mounted Door Closer

Fire Rated Steel Door Frames incorporate a 25mm Stop and a reveal to accommodate either a 37mm or 47mm door panel. Door panels over 2300H x 1020W a fourth hinge is fitted.

Generally frames are supplied with galvanised wire fixing ties for new masonry walls. They may be fitted with countersunk holes and tube spacers for existing masonry walls or welded fixing straps for stud wall applications. (See “Fixing Methods – Page 16)

All frames are warranted as per N.E.D.F. **“Terms & Conditions of Sale”**

# FIRE RATED STEEL DOOR FRAME PROFILES

**TYPE FR1**

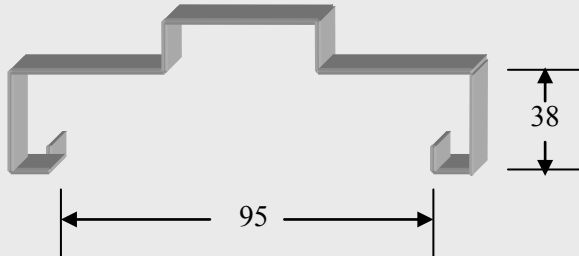

Suitable for:

90mm Blockwork

64mm Stud + 13mm Lining each side

**TYPE FR2**

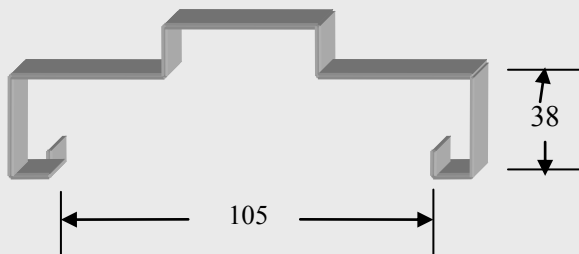

Suitable for:

100mm Blockwork

76mm Stud + 13mm Lining each side

**TYPE FR3**

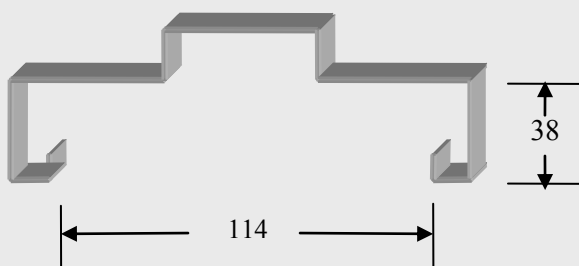

Suitable for:

110mm Brickwork

76mm Stud + 16mm Lining each side

**TYPE FR4**

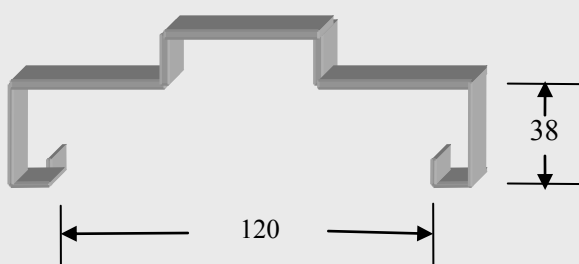

Suitable for:

90mm Stud + 13mm Lining each side

Manufacturing Tolerances +/- 2mm

# FIRE RATED STEEL DOOR FRAME PROFILES

**TYPE FR5**

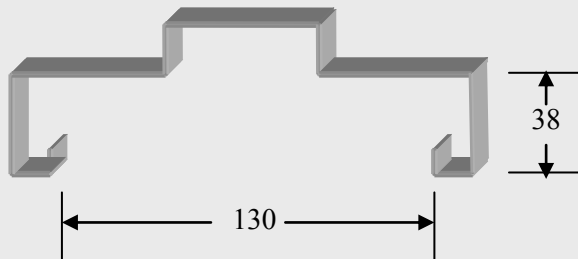

Suitable for:

90mm Stud  
plus 2 x 13mm Lining each side

**TYPE FR6**

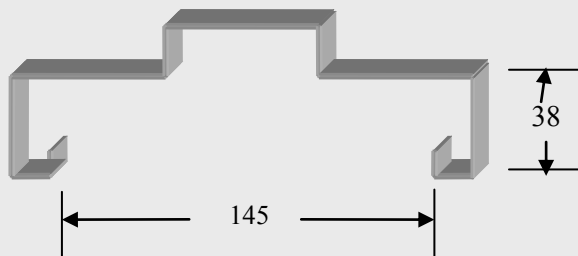

Suitable for:

140mm Blockwork

**TYPE FR7**

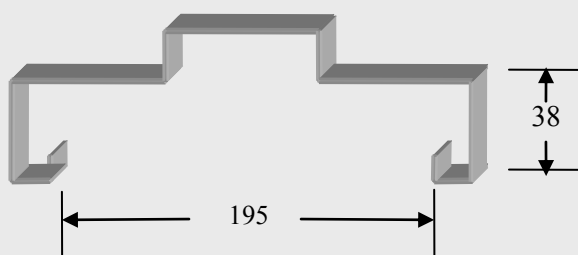

Suitable for:

190mm Blockwork

**TYPE FR8**

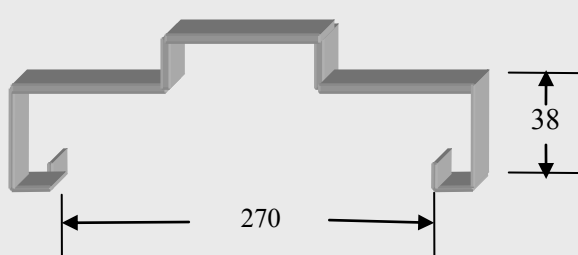

Suitable for:

Cavity Brick Wall

Manufacturing Tolerances +/- 2mm



# FIRE RATED STEEL DOOR FRAME PROFILES

## TYPE FR9

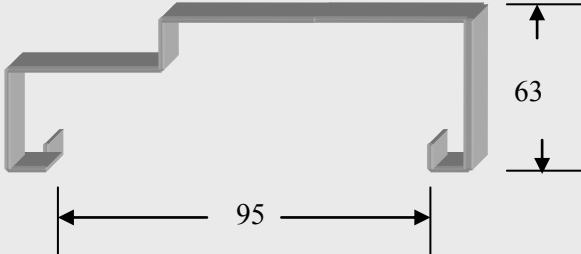

Suitable for:  
47mm Thick Fire Door  
90mm Blockwork

## TYPE FR10

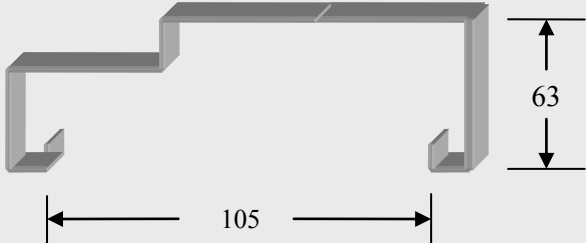

Suitable for:  
47mm Thick Fire Door  
100mm Blockwork

## TYPE FR11

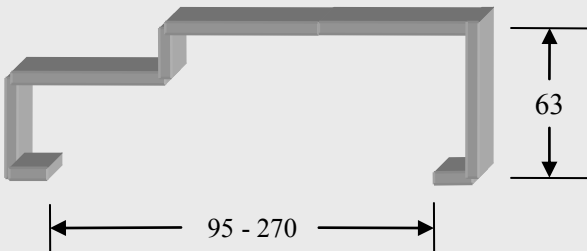

Suitable for:  
2.5mm Thick Frame

## TYPE FR12

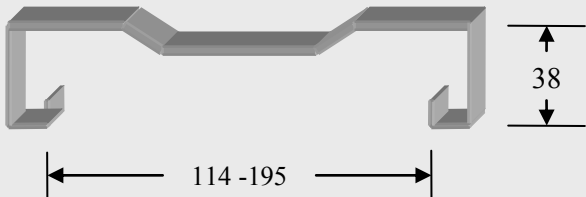

Suitable for:  
Inverted Fire Frame for  
Double Acting Doors

# STEEL DOOR FRAME—FIXING METHODS

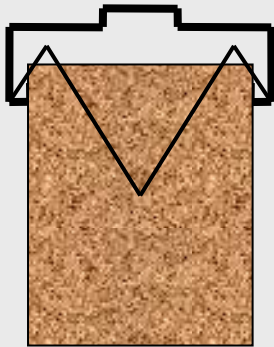

Single Masonry

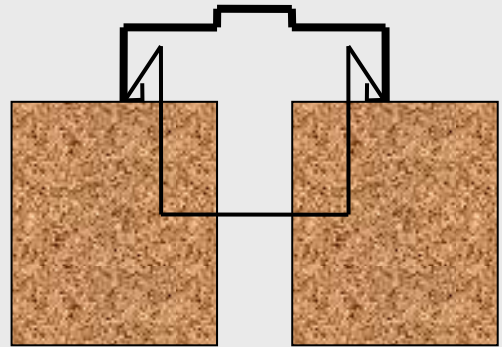

Cavity Masonry

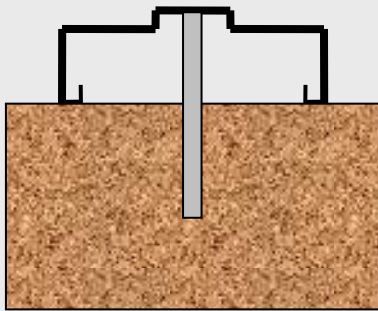

Tube Fixing



Cavity Masonry

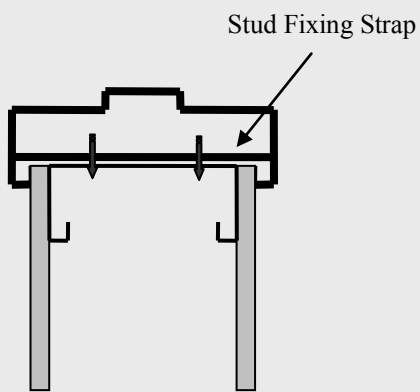

Stud Wall Fixing

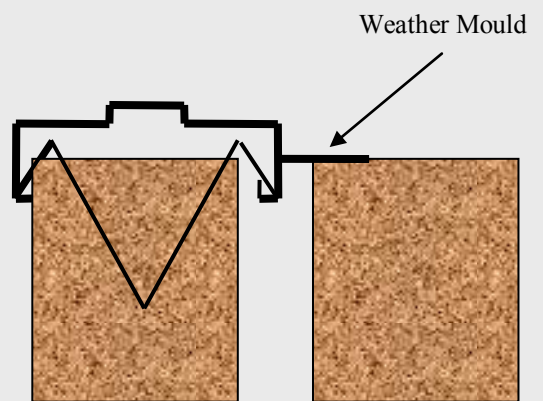

Cavity Masonry

# STEEL DOOR FRAMES—FRAME DETAILS

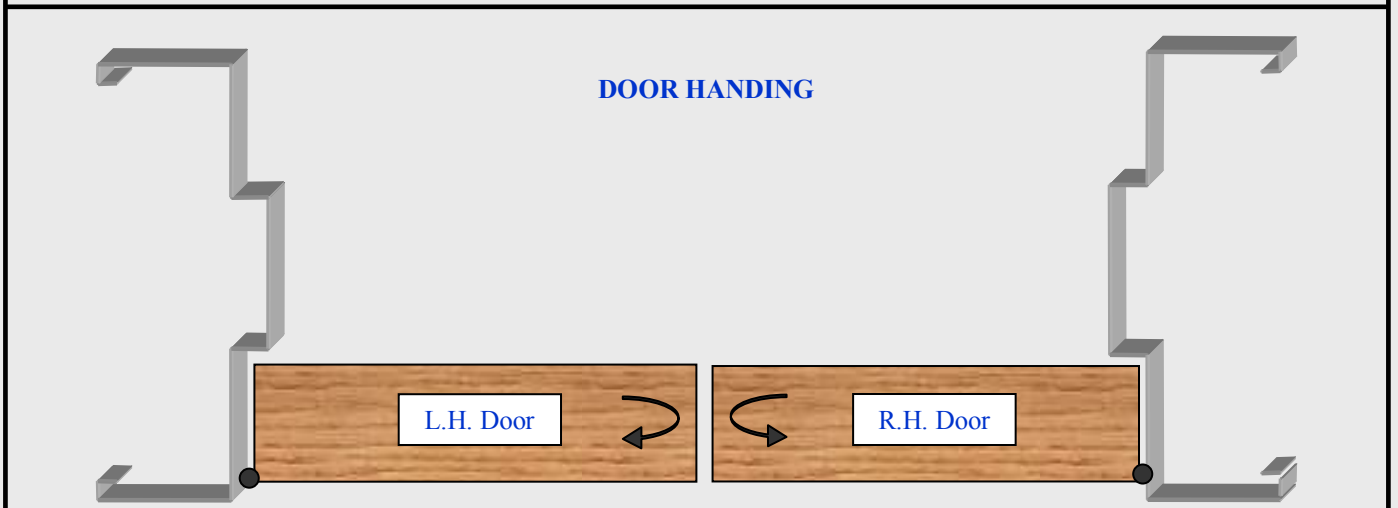
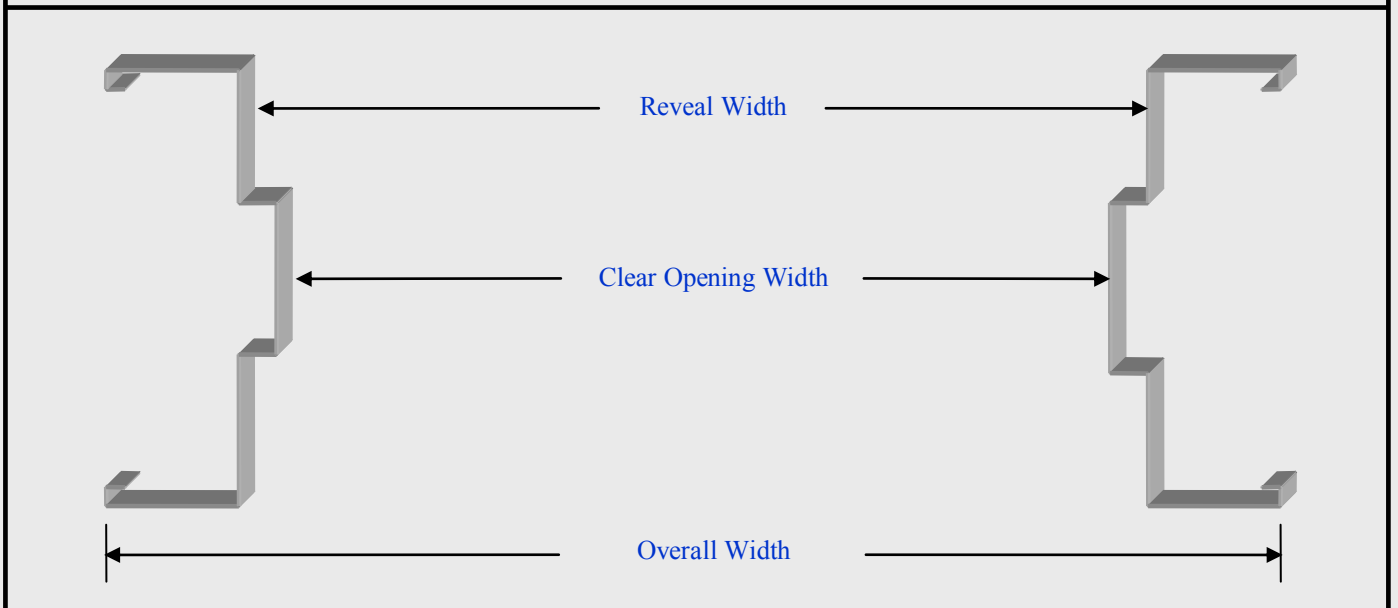
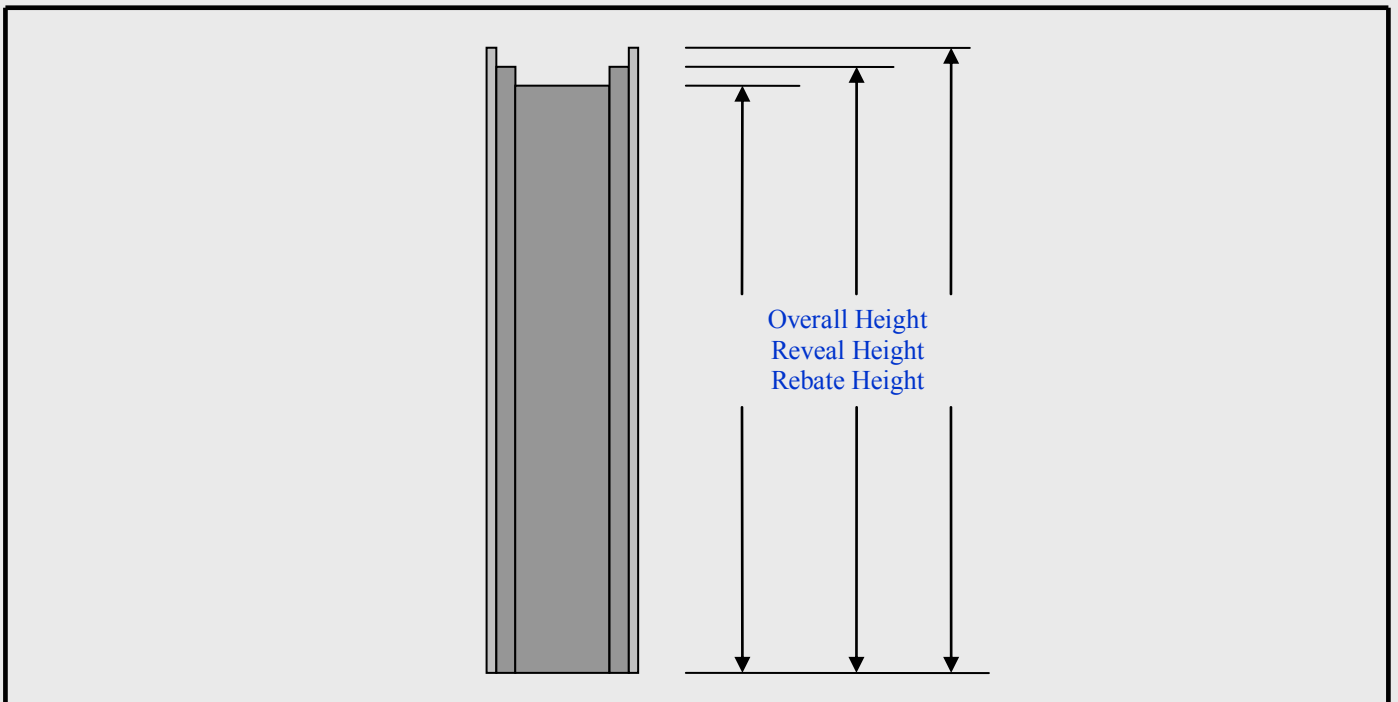

# STEEL DOOR FRAMES SPECIAL PROFILES

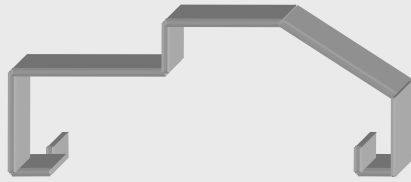

Archifectural Frames

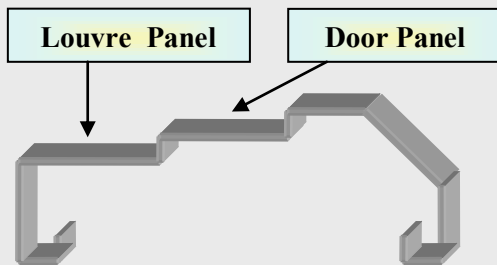

Stormproof Frame  
c/w Louvre Shutters

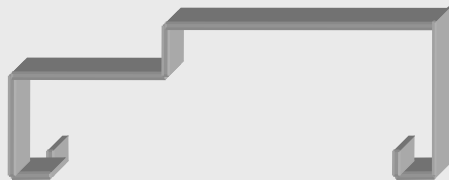

Single Rebate Frame for  
Pre Cast Concrete Walls  
Or Access Panels

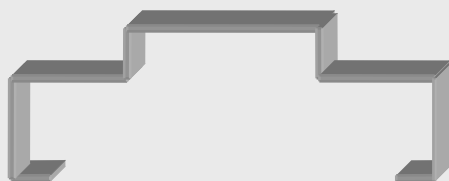

Cap Frame  
(To cover existing or damaged  
Frames)

# SPECIAL STEEL DOOR FRAMES

Manufacturing Tolerances +/- 2mm



**Steel Door Frame  
With Sidelights**

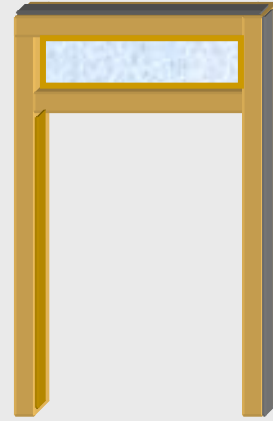

**Steel Door Frame  
With Highlight**

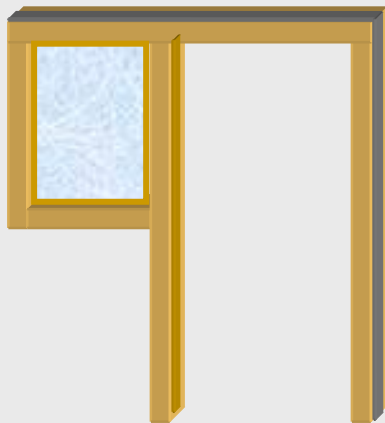

**Steel Door Frame  
With Sidelight**

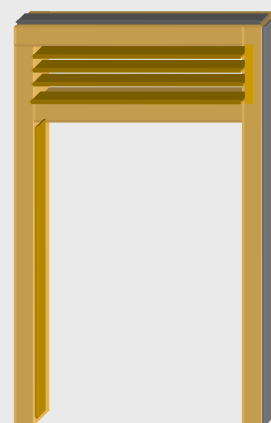

**Steel Door Frame  
With Louvre**



**Steel Factory Windows**

# STEEL CAVITY SLIDER UNIT

## PRODUCT DATA SHEET

The N.E.D.F. Cavity Slider Unit has been designed for an extended life and to be maintenance free. Unlike its timber counterparts, the steel Cavity Slider is extremely rigid as a result of the welded manufacturing procedure; there is no movement within the unit or wall lining when installed. The unit is supplied complete with a track system incorporating two four wheeled rollers per door panel. The tracking system will not allow the door panel to “jump” off the track.

The Cavity Slider Units are manufactured from either “Zincanneal”, “Galvanised” or “Brushed Stainless Steel” and are fully welded throughout. The units are designed mainly for a 92mm Stud Wall but many varying applications are available.

Each unit is fitted with the following:

- ◆ Rubber Stop Buffers
- ◆ Floor Fixing Plates
- ◆ Tracking System
- ◆ Bottom Guides
- ◆ Stud Fixings
- ◆ Pelmets

An optional feature is the inverted meeting stile that may be applied to single door units. This stile allows the leading edge of the door panel to protrude into the face of the stile when the door is in the closed position thus eliminating any gap or “see through”. This is a unique combination for En-Suites or Walk In Robes.

The Zincanneal units are supplied shop primed ready for paint or powder coated to a selected colour from the “Dulux” range of colours.

The Galvanised units are supplied unprimed but all worked areas and joins are Cold Galvanised.

Cavity Slider Units are available in all standard single & double door sizes or special sizes up to 3000 in height and 2500 in width.

Cavity Slider Units can be supplied either fully assembled or unassembled for “on site” assembly.

The following schematics detail the fabrication and installation details.

The product is warranted as per N.E.D.F “*Terms & Conditions of Sale*”.

# STEEL CAVITY SLIDER UNITS

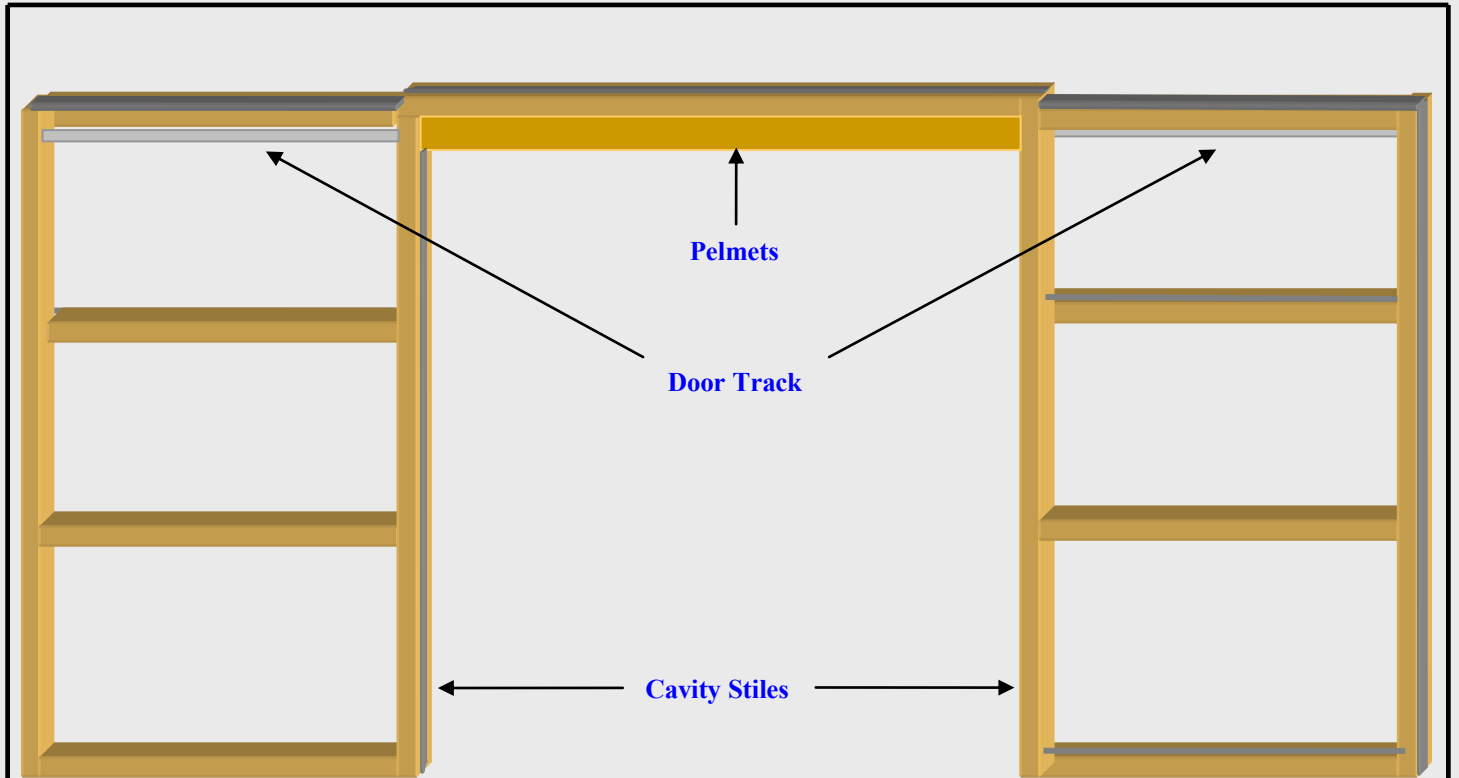

**DOUBLE DOOR UNIT**

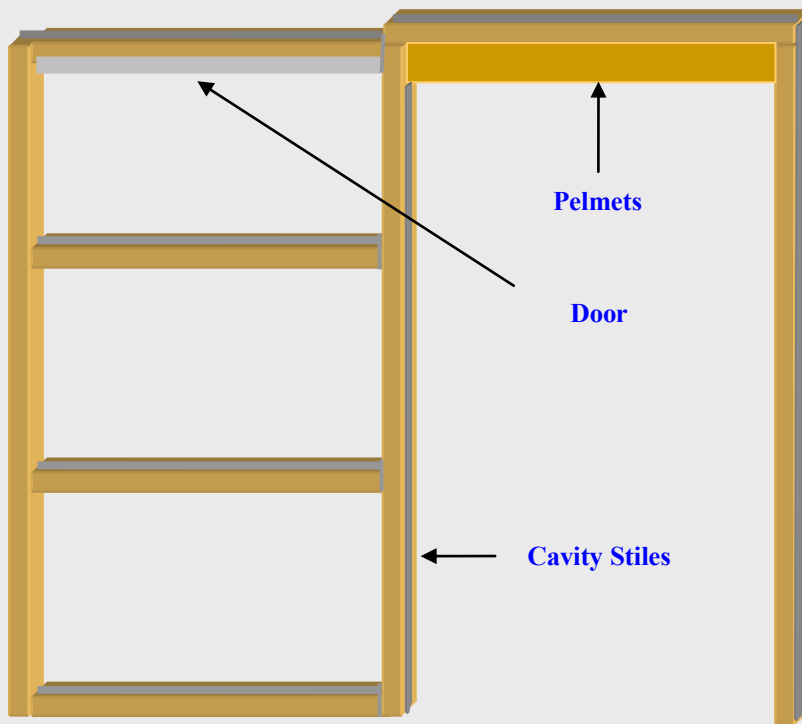

**SINGLE DOOR UNIT**

# STEEL SHEETED DOORSETS

## PRODUCT DATA SHEET

The N.E.D.F. Steel Sheeted Doorset offers quality, security and an appealing smooth or embossed finish and can be adapted to all facets of the Construction Industry from Commercial and Industrial to Domestic applications. The product is available in either standard solid Core or fire rated applications.

The steel sheeted door panels are manufactured utilising either a weatherproof solid core door panel or an approved fire rated door panel. The selected steel sheeting is adhered to the face or faces of the door panel. The edges of the panel are capped all round with the selected steel and weatherproofed. Products manufactured from Zincanneal Steel are then shop primed with a rust inhibitive, phosphate based primer, ready for paint.

Selected steel facings utilised in the manufacture of the products are:

- ◆ Zincanneal
- ◆ Galvanised
- ◆ Brushed Stainless Steel
- ◆ Embossed Stainless Steel
- ◆ Colourbond
- ◆ Embossed Colourbond

All steel facings range in thickness from 0.6mm to 1.5mm.

Options available include Anti-Jemmy Bars, Viewing Panels, Louvre Inserts, Return Air Grilles and Powdercoating with a selected colour from the "Dulux" range of colours.

Pairs of doors are fitted with a full length 40mm x 3mm steel overlapping meeting stile to the active leaf to afford added security and weatherproofing.

The Steel Sheeted Door may be factory fitted to its accompanying steel Door Frame and despatched as a complete unit.

Preparations for Door Hardware may be applied if the Hardware is supplied by the Client prior to the commencement of manufacture.

Each Doorset is warranted as per N.E.D.F. "Terms & Conditions of Sale".



# STEEL SHEETED DOORSETS



**PLAIN DOORSET**

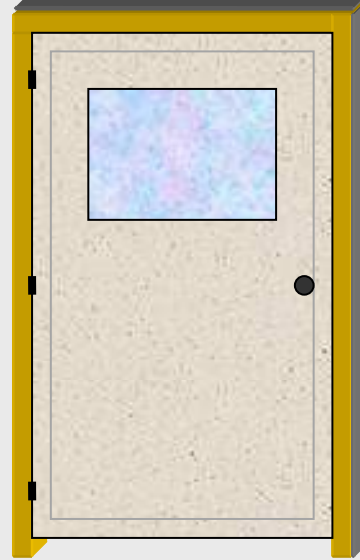

**DOORSET WITH VIEW PANEL**

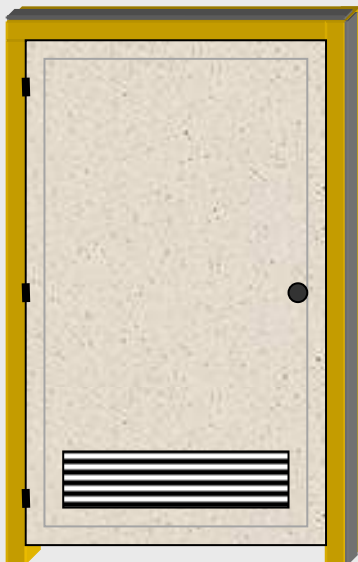

**DOORSET WITH AIR GRILLE**

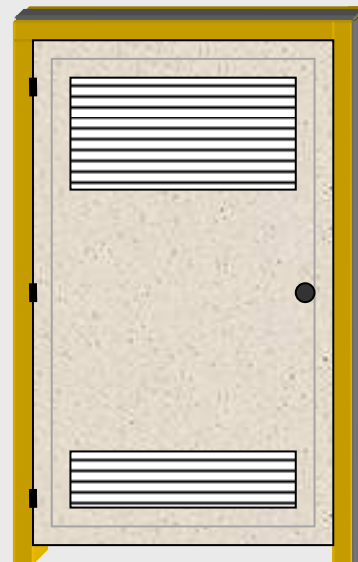

**DOORSET WITH LOUVRES**

# STEEL DOORSETS

## PRODUCT DATA SHEET

The N.E.D.F. Steel Door sets offer quality, security and a smooth or embossed finish and can be adapted to all facets of the Construction Industry from Domestic to Commercial and Industrial. Modifications to our standard manufacturing procedures are available to suit most specialised projects.

The Steel Door Panels are constructed with an RHS inner frame with cross bracing. The inner frame is filled with HD Polystyrene and a "Mid-Rail" section is formed containing a wooden block to accommodate the door Hardware. The outer faces are then sheeted. The edge sections of the door panel is capped all round with the same material as the facings.

Steel Doorsets can be manufactured using one of the following materials:

- ◆ Zincaneal
- ◆ Galvanised Steel
- ◆ Colourbond
- ◆ Brushed or Embossed Stainless Steel

Pairs of doors are fitted with a 40mm x 3mm Anti Jemmy Bar. This bar may also be fitted to the leading edge of a Single Door Panel. Zincaneal doors are shop primed prior to despatch. Powder coating is available in selected colours from the "Dulux" range.

Door Panels may be pre-fitted to their accompanying steel door frame and despatched as a complete unit.

Door Panels may be fitted with Air Grilles, View Panels, Louvres or Perforated Steel Sheet.

The Door sets are available in all sizes including double pairs with centre mullion or overhead fixed or removable transoms.

Each Door set is warranted as per N.E.D.F. "Terms & Conditions of Sale"

# STEEL DOORSETS

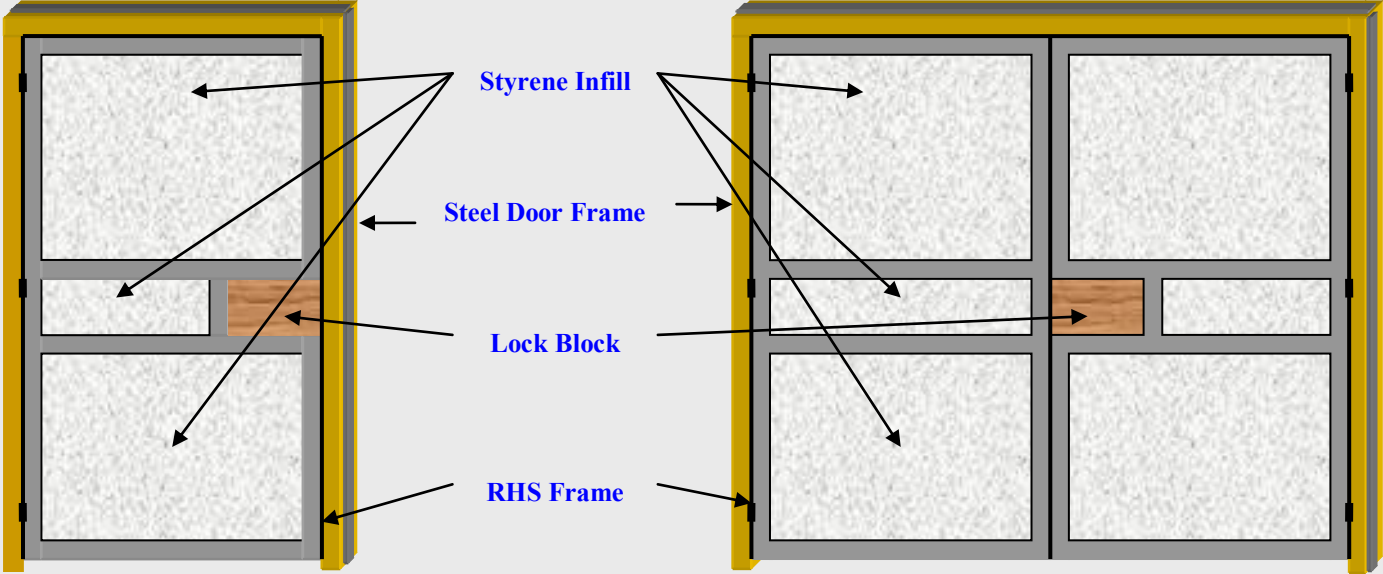

SINGLE DOOR PANEL

DOUBLE DOOR PANELS

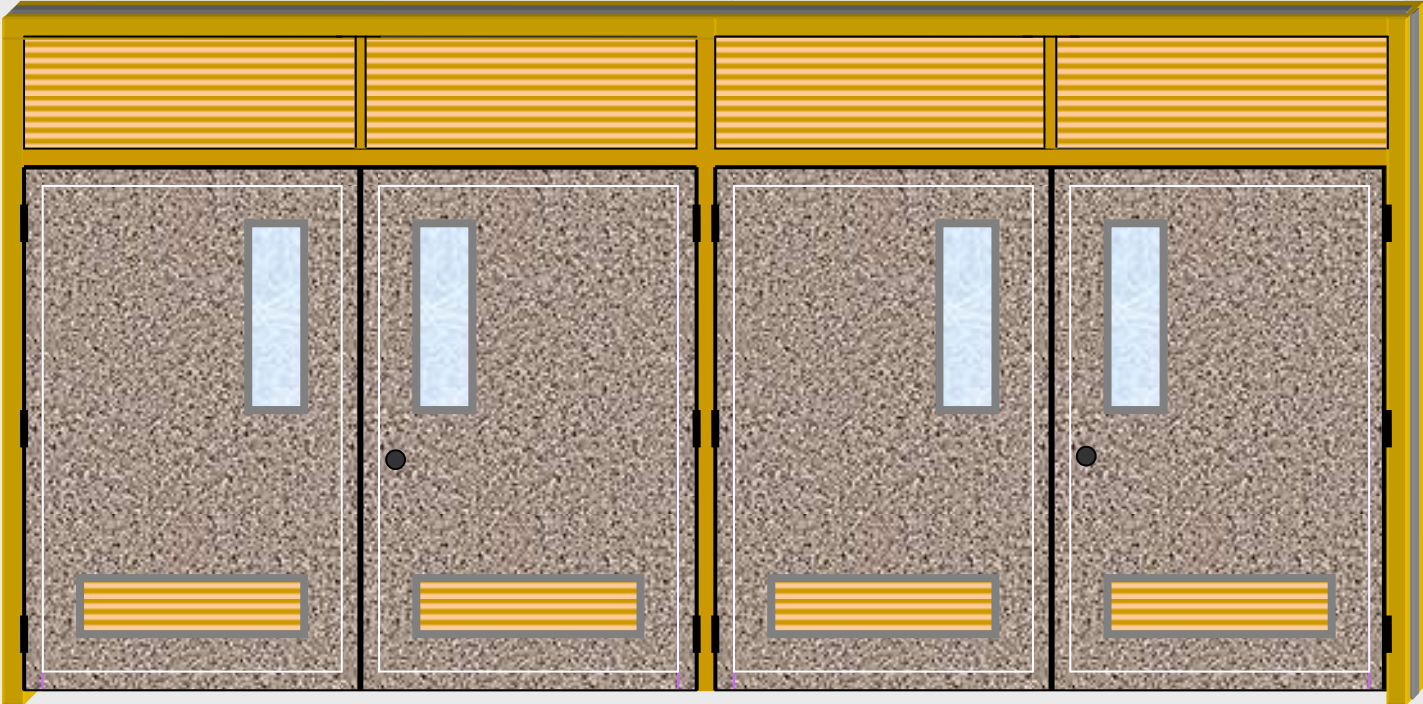

DOUBLE DOORSETS WITH LOUVRES OVER, VIEW PANELS, AIR GRILLES & CENTRE MULLION

# STEEL LOUVRES & LOUVRE DOORSETS

## PRODUCT DATA SHEET

The N.E.D.F. Steel Louvres and Steel Louvre Door sets offer security, ventilation and weatherproofing.

Our louvres are adaptable to all facets of the Construction Industry from Commercial and Industrial to Domestic. With their pleasing "Colourbond" finish, they enhance the appearance of plant rooms, sub stations, car parks and any other application for which they may be required.

The units are manufactured from either Zincanneal, Galvanised or Brushed Stainless Steel. Steel Mesh may be fitted to the rear face of the units for vermin proofing.

An optional 10mm steel rod may be applied to each louvre vane for added security. Louvre Door sets incorporate provision for the required door hardware and are supplied pre-fitted to the accompanying Steel Door Frame prior to despatch.

Single Louvre Door sets are available in all sizes from 2040 x 620 to 3000 x 1200 and include provision for door hardware.

Double Louvre Door sets are available in standard pairs of 2040 x (2)620, 2040 x (2)720 or 2040 x (2)820 with special sizes up to 3000 x 2400. Pairs of doors are fitted with an anti-jemmy bar to the active leaf and provision for door hardware.

Fixed Louvre Panels are available in various shapes and sizes up to 3000 x 2400 and are manufactured to suit the many varied types of wall construction used today.

All Louvre sets, with the exception of stainless steel, are supplied "Powdercoated" in a selected colour from the "Dulux" range.

The products are warranted as per N.E.D.F. "*Terms & Conditions of Sale*"

# STEEL LOUVRES—MANUFACTURING PROFILE

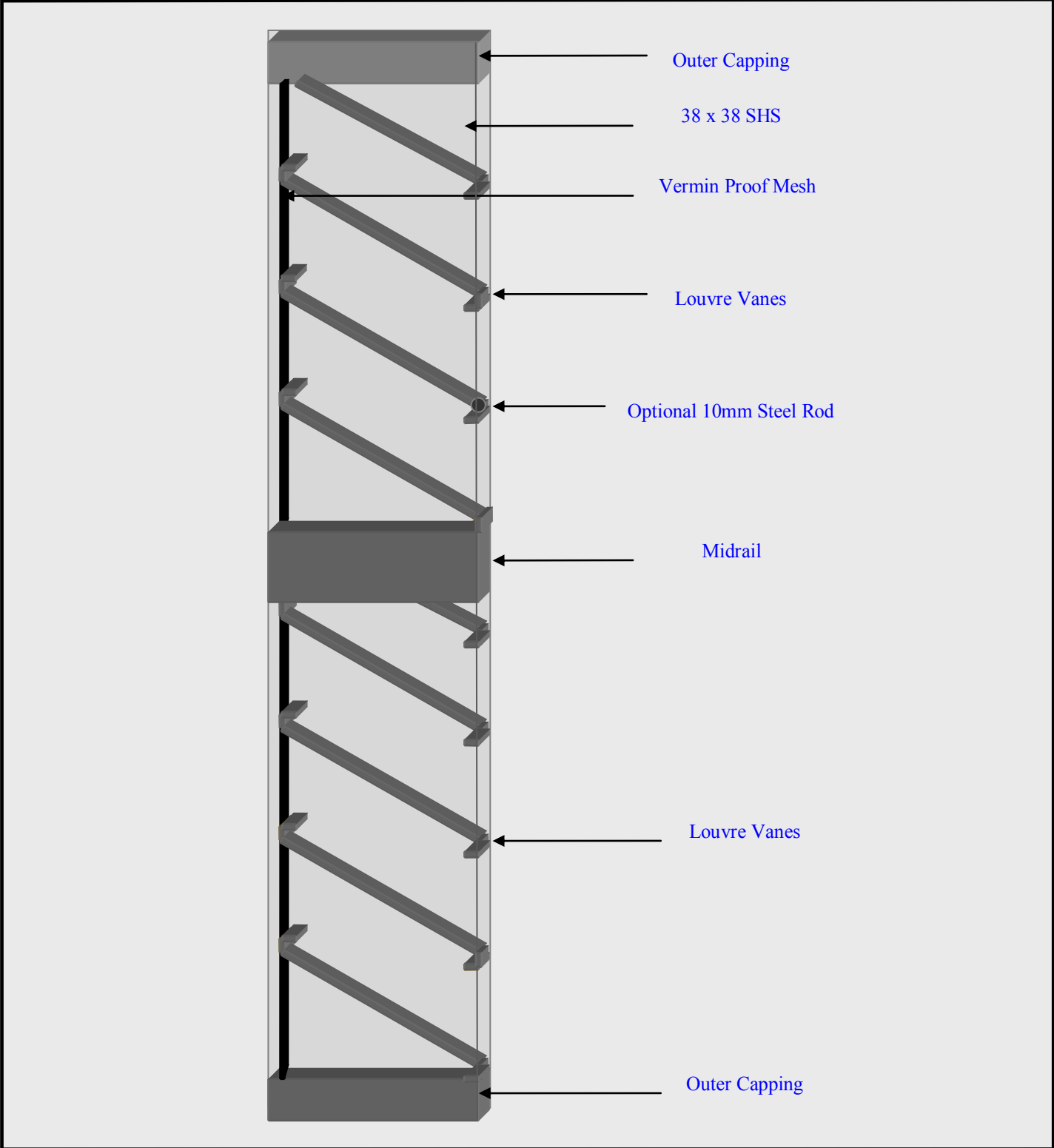

The louvre blades will be welded to 38 x 38 x 1.6mm SHS steel section that makes the perimeter of the door panel. The SHS will then be fully capped with 1.2mm zincannel.

# FIXED LOUVRE PANELS

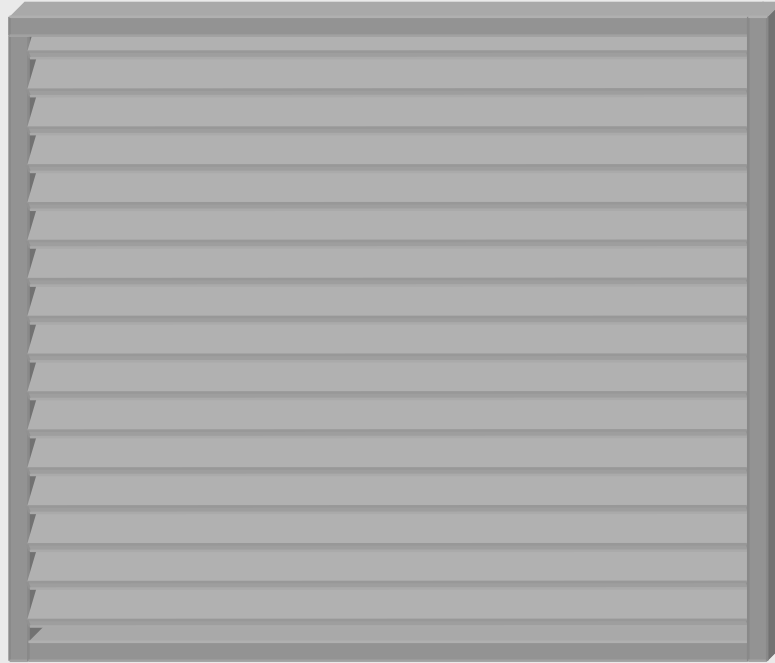

**SINGLE FIXED LOUVRE PANEL**



**DOUBLE FIXED LOUVRE PANEL**

# STEEL LOUVRE DOOR ASSEMBLY



**SINGLE LOUVRE DOORSET**

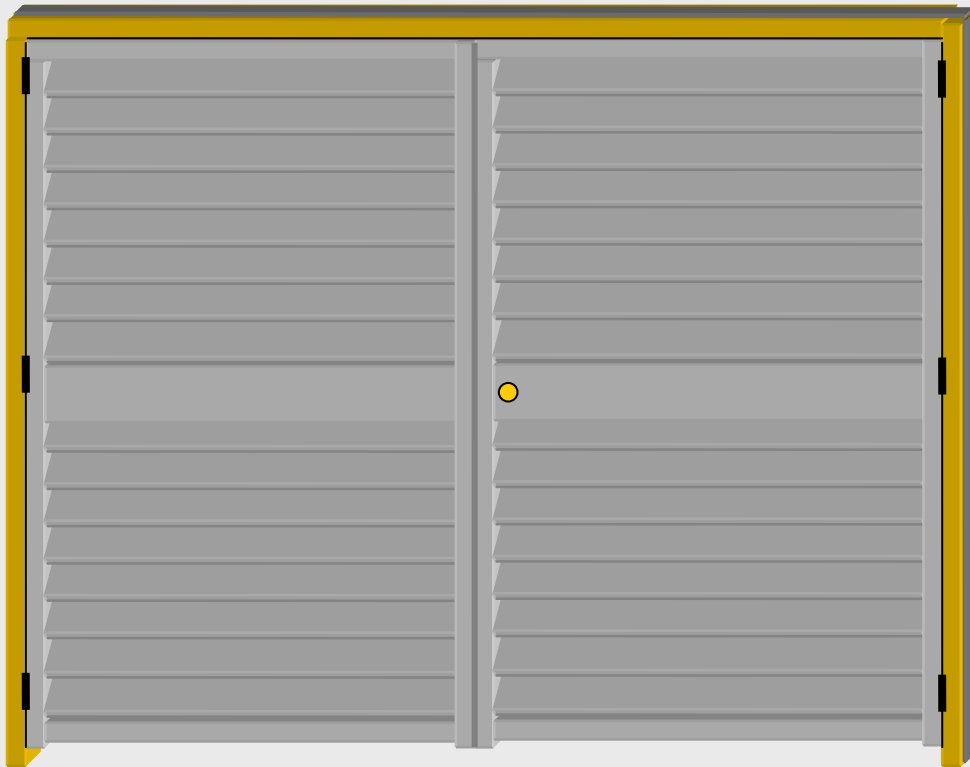

**DOUBLE LOUVRE DOORSET**



**DOUBLE LOUVRE DOORSET WITH FIXED LOUVRES OVER**

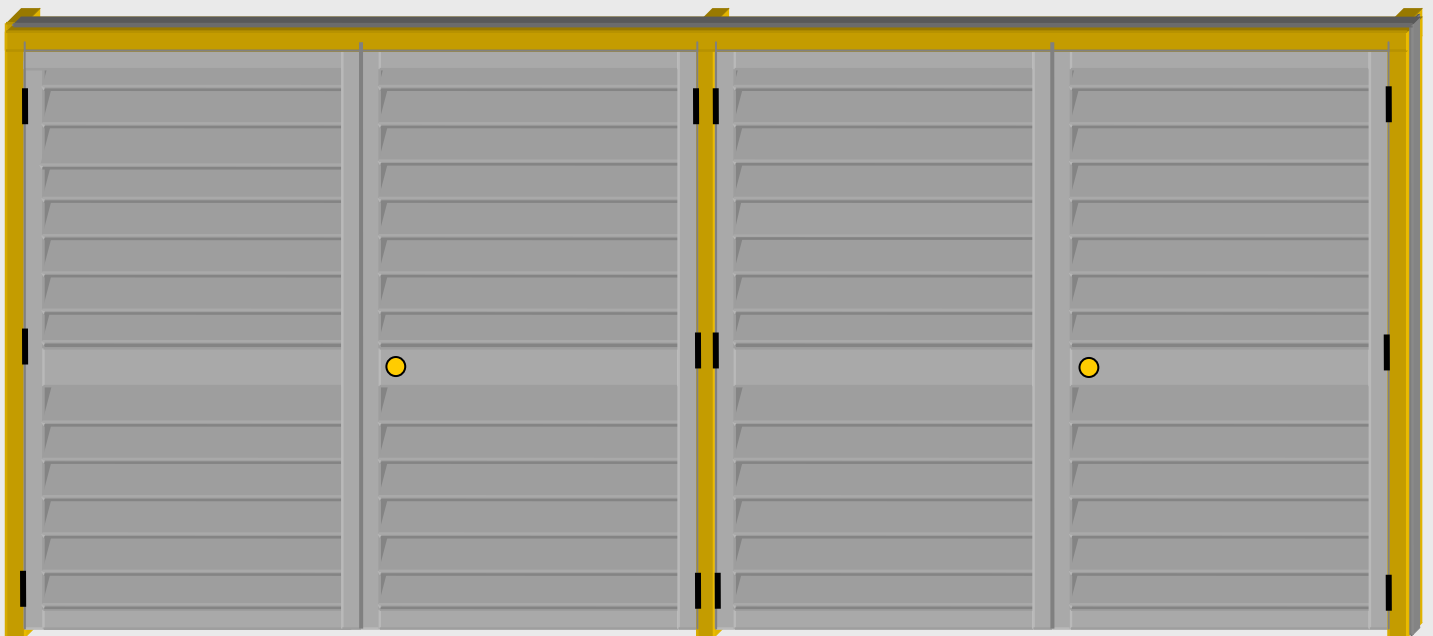

**LOUVRE DOORSETS WITH CENTRE MULLION**